

The A696 soft recovery diode is designed for high frequency applications to 3000 Hz and is proven as a bypass diode in PWM inverter circuits. It is recommended as a companion diode for the C712 thyristor.

Features:

- Reverse blocking to 2500 volts
- Prespak design for double-sided cooling
- Full energy characteristics for forward conduction and reverse recovery

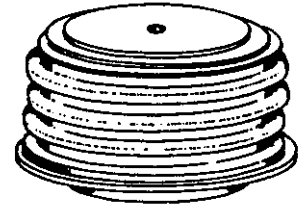

**MAXIMUM ALLOWABLE RATINGS**

TYPE	REPETITIVE $V_{RRM}$ $T_J = -40^{\circ}\text{C to } +150^{\circ}\text{C}$	REPETITIVE $V_{RRM}$ $T_J = 0^{\circ}\text{C to } +150^{\circ}\text{C}$
A696LD	2400 volts	2500 volts
A696LC	2300	2400
A696LB	2200	2300
A696LA	2100	2200
A696L	2000	2100

Average Forward Current ..... 1000 Amperes, 1 $\Phi$  Average  
 Peak One-Cycle Surge Current ..... 14,000 Amperes  
 Maximum On-State Voltage Drop (at 1000 Amps, 25 $^{\circ}$ C) ..... 1.9 Volt  
 Peak Reverse Leakage Current ( $T_J = 150^{\circ}\text{C}$ ,  $V = \text{Rated } V_{RRM}$ ) ..... 100 mA  
 Maximum Thermal Resistance,  $R_{\theta JC}$ , Double-Side Cooling (DC) ..... .037 $^{\circ}\text{C/Watt}$   
 Storage Temperature,  $T_{stg}$  ..... -40 $^{\circ}$ C to +150 $^{\circ}$ C  
 Operating Junction Temperature,  $T_J$  ..... -40 $^{\circ}$ C to +150 $^{\circ}$ C  
 Mounting Force Required ..... 3500 – 4200 Lbs.  
 15.6 – 18.7 Kn

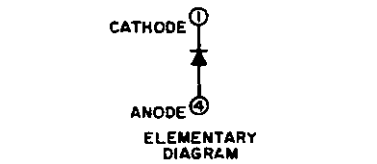
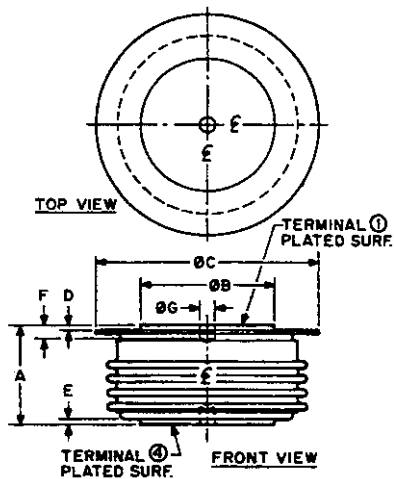

SYM.	INCHES		MILLIMETERS	
	MIN.	MAX.	MIN.	MAX.
A	0.990	1.040	25.15	26.42
$\phi B$	1.330	1.350	33.78	34.29
$\phi C$	-	2.300	-	58.92
D	0.040	0.090	1.02	2.29
E	0.005	0.090	0.13	2.29
F	0.070	0.100	1.78	2.54
$\phi G$	0.136	0.146	3.45	3.71

NOTE:  
GLAZED CERAMIC INSULATOR  
WITH 1 INCH (25.40 mm)  
SURFACE CREEPAGE, MIN.

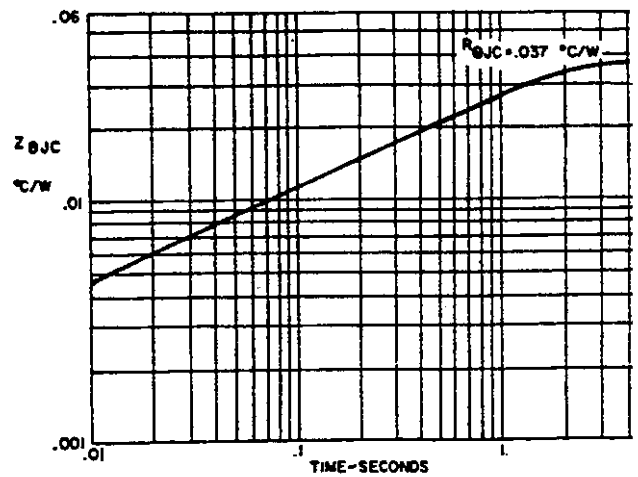

**TRANSIENT THERMAL IMPEDANCE –  
JUNCTION-TO-CASE**

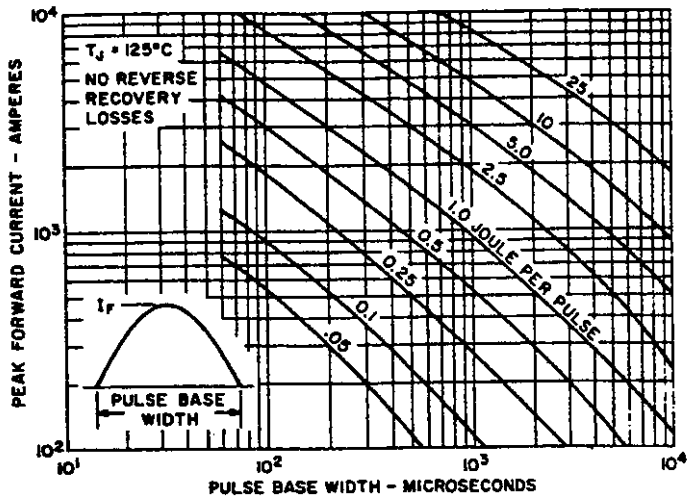

SINUSOIDAL SWITCHING LOSSES

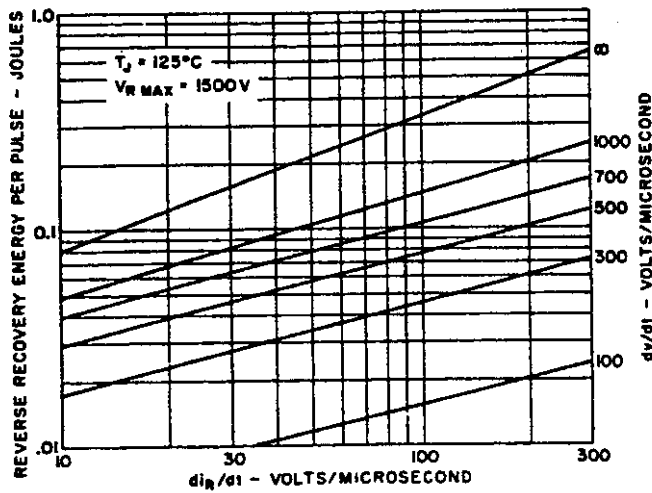

REVERSE RECOVERY

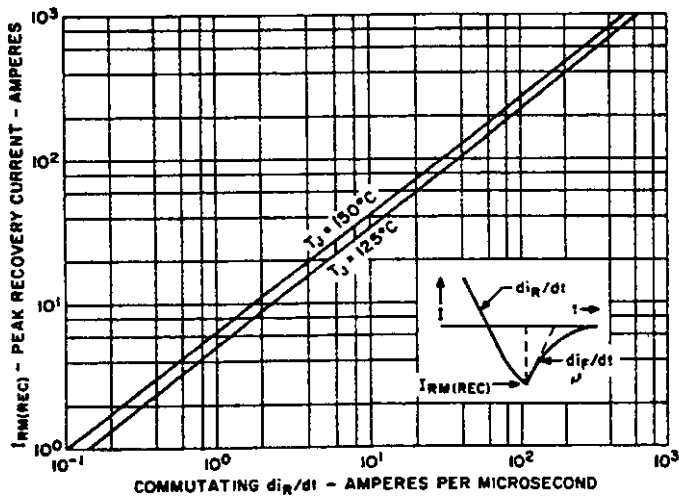

REVERSE RECOVERY CURRENT CHARACTERISTICS

\* Critical resistance decreases as applied voltage is increased. (approx -10% @ 1200V)

Technical reference:

IEEE/IAS 1978 Annual Meeting pg. 1036

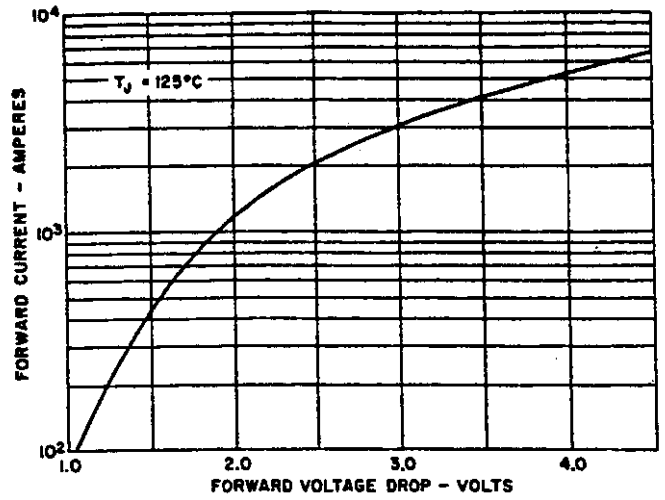

MAXIMUM FORWARD VOLTAGE DROP

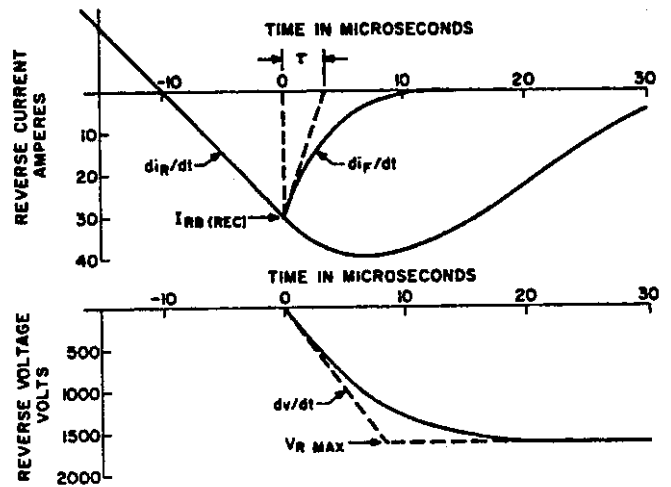

Controlled commutation is assured for values of snubber resistance below a critical value as indicated in the families of curves. \* The factory controlled test point signified by the mark (●).

This dictates a restraint which must be considered along with many other factors for snubber circuit design.

If the critical value is exceeded the diode may recover abruptly, developing a high reverse  $dv/dt$ .

